

2022 Catalogue



Brand Vision

Creating brands that last

DOES YOUR BUSINESS NEED ATTENTION?

Let's help bring out only the best in your brand.

Graphic Design Services

- ✓ Logo Creation
- ✓ Branding Concepts
- ✓ Signage Design
- ✓ Booklet Layouts
- ✓ Online & Social Media ADs

Certified
Professionals



Contents



How to make the most out of this booklet

As read through each section, further details are written at the bottom however if you need any further assistance please contact our graphic design team via design@brandvision.co.tz.

Copyright ©2022. BRAND VISION (SEIFEER GRAPHIC & DESIGNERS)
All rights reserved. No part of this book may be reproduced, stored in a retrieval system, or transmitted by any means; electronic, mechanical, photocopying, recording, or otherwise, without written permission from the copyright holder.



Exceptional Solutions. Creating Brands That Shine & Last.

About Us

Brand Vision is a trade name under SEIFEE GRAPHIC & DESIGNERS which was founded and licensed in the United Republic of Tanzania.

At Brand Vision we have set a clear and definitive goal; to never compromise on anything thus execute our projects with an in-depth knowledge of the market.

Throughout the years of experience, we have worked with prestigious companies and helped them succeed in rigorous markets.

Our success formula combines internationally experienced, creative and strategic thinkers with deep knowledge of local culture.

Why work with us?

- 1 Exceptional Customer Service
- 2 A wide Range of Services
- 3 We are Experts
- 4 Superior Service & Product Quality
- 5 Our Prices are Honestly Fair

Our Services



Graphic Design

Stunning artworks that capture targeted audiences.



High Quality Printing

We pay close attention to every detail of your work.



Strategic Advertising

We ensure that you get the right platform for marketing.

Creative

GARMENTS & APPAREL





Garment Printing

Round Neck T-shirts



Available Colors:



Full Color Picture
Color Flex Transfer



Full Color Logos

Polo Neck T-shirts



Available Colors:



General Specifications

70% Cotton 30% Polyester
Half Sleeve, 200gsm
Sizes available: S, M(F), L, XL, XXL



Caps



Available Colors:



Embroidery of artwork on front, side and back.

Structured six panel, heavy brushed cotton cap with embroidered eyelets, a pre-curved peak, a sweat band and an adjustable closure complete with a metal buckle which allows one size to fit most people.

Aprons, Lab Coats, Overalls

Your brand logo can be placed at the front or any chosen area of the apron.
Colors and size varies with client choice.



Embroidery:

Stitches logos directly onto a garment using digital sewing machines.



Screen Printing:

Squeezes ink through a stencil & screen, directly onto a garment.



Heat Press Printing:

Printing that uses heat to transfer a printed logo onto a garment.



Sublimation:

A method of printing that transfers a graphic design into a material.

Artwork:
Resolution 300ppi or higher
Acceptable printing file types:



Cap Details:
70% Cotton 30% Polyester
Other Details: 300gsm. One size fits most people.





Bags & Back Packs

Back Packs



Custom printed or embroidered back-packs, including gift bags tote bags, Perfect exhibition giveaways.



Hand Bags

Travel Bags

Laptop Bags

Available Colors:



Assorted Shopping Bags



Eco friendly Bags

Custom printed, string bags, gift bags, non woven bags & paper bags available.



Eco Paper Bags



String Bags



Glossy laminated 157gsm art paper and can be branded with stunning edge-to-edge full color printing on all sides including the base.

General Specifications

Printing Option: Screen Printing, Embroidery & DTG (Direct to Garment)
Paper Bag Sizes available: A4 & A3

Colors:



Face Masks



Reusable face mask which provides protection. Hand washing in warm water. Comfortable elastic ear loops: black or white. The front panel can be branded with stunning color prints.



Handkerchiefs & Other Giveaways

Please note that for all other apparel, the materials and other details are subject to availability and customer preference for us to get the job done.



Protective Work Wear

We are a trusted supplier of quality, custom-branded work-wear & apparel.

We specialize in custom-branded Work-wear suited to the Tanzanian climate for mens and ladies.

Request a quote for pricing.

Available Colors:



Artwork:
Resolution 300ppi or higher
Acceptable printing file types:



Mask Details:
Materials: 140gsm Polyester.
Printing Options: Screen Printing, Sublimation





DTG Printing

Direct to Garment Printing



DTG printing offer a lot of color options which means you can print detailed designs and photo-realistic images with almost no color limitations. This is important for those businesses that want to try out various colors and designs.

Artwork Size: A4 & A3

Garment Flex Cutout



It's designed for transferring solid color logos, graphics or text onto cotton and polyester fabrics. It's fast and suitable for lightly coated textiles. It has a matte finish and a soft touch.

Available Colors: {12 standard, 4 neon, 2 metallic }



Print on all textiles

Use every unique opportunity to market your brand.

General Specifications

Artwork:
Resolution 300ppi or higher
Acceptable printing file types:



Printing

LARGE FORMAT



Rollup Banners

Standard Rollup Banners



The roll up classic is suitable for costs and is portable. It's complete: with stand and canvas with print, and is highly suitable for conventions and presentations.

And is easy to set up.



Carrier bag included.

Broad Base Rollup Banners

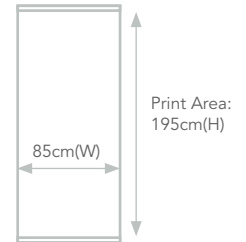

General Specifications

Available Color: Silver / Aluminum
Standard size available for both banners: 85cmx205cm



Electric Rollup Banner



Print Area:
200cm(H)

Available Color: Silver
Standard size for both
sides: 85cmx407cm

Our Electric Scrolling Banner Stand is perfect for trade show conventions, car or boat shows, hotel lobbies or point-of-purchase displays at retail stores. The movement of this display is sure to catch the eye of a nearby audience and peak interest in the information on the printed banner.



Various stand options

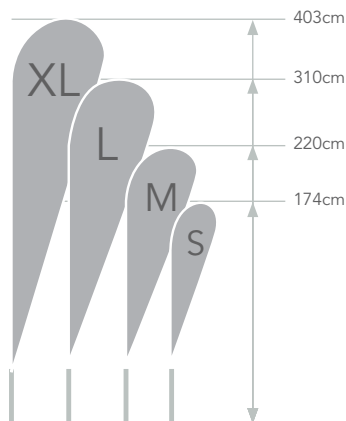

Teardrop Banner

Dye sublimation printed image or design, attached to an aluminum and fiberglass pole (bag included).

Available Color: Silver
Various Sizes : 174cmx74cm
220cmx75cm, 310cmx105cm,
403cmx111cm

Artwork:
Resolution 300ppi or higher
Acceptable printing file types:



Tear drop Banner Details: One-sided Printing
Assembling the elements of the pole + attaching the print
by sliding the pole into the material tunnel.

Barox Soap



Promotional Table

Promotional Table



These tables are portable, easy to handle and reassemble. The whole unit can be used to display your marketing campaign in societies, promotional events, shows, exhibition, indoor and outdoor promotions of products or surveys.

Easy to install and de-install.

Can be used multiple times by simply replacing previous prints from display tables with new ones.

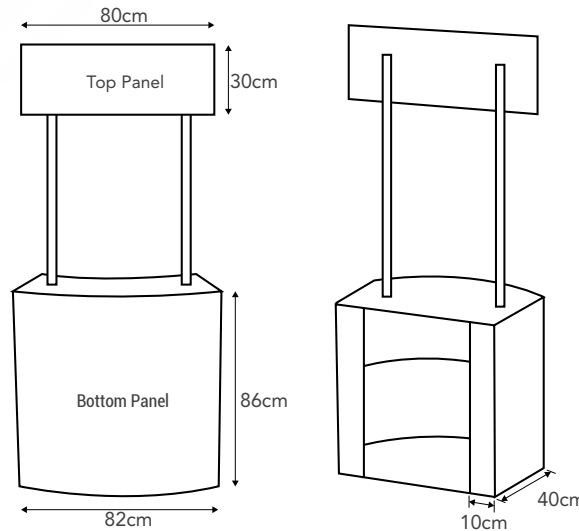

Available Colors:

● White

General Specifications

Material: ABS body or plastic table structure frame, Vinyl printing.
Artwork size as per above specifications.

Square Drop Flags



Various stand options

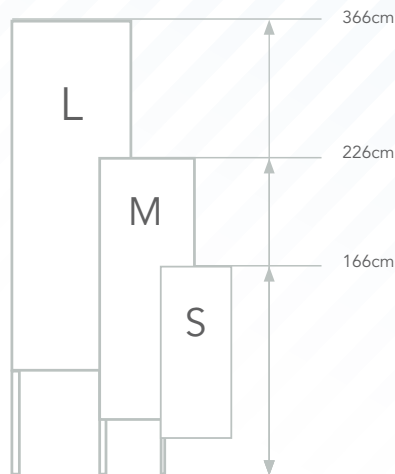

Outdoor pole for rectangular flag. Black tubular construction is easily assembled into a flagpole. Supplied in a bag, with a base and banner/flag.

Available Color: Silver
 Various Sizes : 166cmx70cm,
 266cmx70cm, 366cmx70cm



Jumbo Banner Stand

The Large Format Banner with Stand and it's portable.

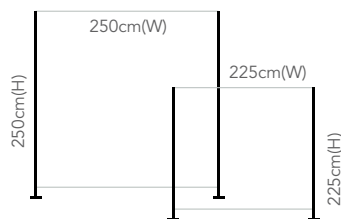

Top Area



Top Area



Artwork:
 Resolution 300ppi or higher
 Acceptable printing file types:



Available Color: Silver / Black
 Available Sizes : 250cm(W) x 250cm(H), 225cm(W) x 225cm(H)
 One-sided Printing; comes complete with carrier bag.

A4 Snap Frame Stand



A-Frame Single & Double Sided



Available Size: A1-59.4cmx84cm

X-Banner Stand



X-banner is complete with stand and carrier bag.
Available Size: 80cmx180cm

Fabric A-Stand



Available Size: 280cm(W) x 100cm(H)

Portable Tear drop, Telescopic & X-stand



These are excellent for marketing campaigns on the move. Printed in full color dye sublimation on super poly knit fabric and comes with a carrying case.

Artwork:
Resolution 300ppi or higher
Acceptable printing file types:



Ask our team for specifications of any item you may need.
Please call: +255 736 551 608 Email: design@brandvision.co.tz

Outdoor Flag

Built tough with a water weighted base to keep your brand high above the competition even on those windy days.

The full color dye-sublimated graphic in the popular rectangle style maximizes your exposure from afar. An excellent solution for outdoor festivals, sporting events and trade shows.

It is Lightweight, Portable and Easy to Assemble.

Kit Includes

- (1) Single sided graphic
- (1) Aluminum pole
- (1) Spike base
- (1) Travel bag

Available Size: A1- 59.4cmx84cm



Double Sided Spring Pavement Sign A1

It's supported by heavy-duty brackets at the base of the sign. The added wheels make transportation and storing effortless.

Color: Silver

Available Size: A1- 59.4cmx84cm



Parking Stand

Cone outdoor custom fillable sign with customized Vinyl Text. Size: 35cmx40cm



A4 Mini Roll Up



Available in silver color
Size: 21cmx30cm

Artwork:
Resolution 300ppi or higher
Acceptable printing file types:



Ask our team for specifications of any item you may need.
Please call: +255 736 551 608 Email: design@brandvision.co.tz

Velcro Pop up Display



This FAST-LANE outdoor banner display is suitable for different displays, shows, malls, conferences and designer promotions not to mention is easy to set up too.

Material: PVC Fabric high resolution and vibrant print color.
Available in silver color.
Size: 225cmx300cm

8 Folding Panel Partition



8 Folding Panel is kind of display system which is flexible to adjust the display panel direction and shape. It is combined by 8 pieces of single panel and without any tools or equipment for installation

Size: 240cm(W) x 180cm(H)
Graphic Size: 55cmx85cm (each Single Panel)
Material: Aluminum

Ellipse Light Box

Size: 37cmx150cm



Street Poles Clamp Advertising

Two piece cast aluminum base with removable fiberglass.

Available Size:
37cmx150cm



Custom Designed Exhibition Stands



Exhibition Booth



Transform your brand into a larger than-life event for attendees and staff with exhibit design that includes creative architecture, bold graphics and interactive elements.

We can help with all aspects of your memorable experience.

We have a variety of exhibition systems that are compatible to create nearly any look and meet any function imaginable.



We are able to fabricate from simple exhibition stands to complex stands; to all your required specification.

Quotation vary with features and space specifications.

Please talk to our experts for further information.

Contact us via: +255 736 551 608 Email: design@brandvision.co.tz

Office Interior



A great office interior design will accurately mirror core values and strategic objectives and will increase the productivity in your staff. From start-ups to corporations, we are transforming work spaces.

We design and remodel;

- **Cupboards**
- **Board rooms**
- **Office Furniture**
- **Office Lounge**
- **Work Stations (Desks)**

When designing, we create unique projects and incorporate the best of creative ideas, which is why interior design can rarely have any rules attached to it.

Interior design concept statements combine the most important ideas & processes contained in your interior design proposal.



Building Signage

Building Signage

Building signage is often overlooked, but the savvy business owner knows it can be the most powerful marketing tool you can have. They serve as a visual communication for your brand and can draw customers in. Building signs can be used both on the interior and exterior of your building. We've been designing, manufacturing and installing a wide range of innovative building signs to help our clients stand out. Our in-house team of designers, craftsmen and engineers have the creativity, expertise and tools to bring any idea to life, with any type of signage, for any application.

- ACM Boards, AluPanel,
- Diabond, Alucobond
- Acrylic Signs
- Fascia Signs
- Faux Neon Signs
- Flex Face Signs
- Fret Cut Lettering
- Illuminated Signs
- Monolith / Totem Signs
- Steel Erect Signage
- Wall Graphics
- Window Manifestations
- 3D Built up Letters



General Specifications

Depending on the type of signage, size and position of placement, our professionals will inspect your location and will give you a quotation afterwards.

Directional Signs



Visitor
Entrance

6011
6021
6031

Connection
Drive

Customized Signs

From cozy beach boardwalks to professional business environments, people need to know where they're going. A natural sense of direction can only get somebody so far. You can solve any organizational issues you might have with custom directional signage, which will outline your property in a visually appealing way that aligns with your current aesthetic.

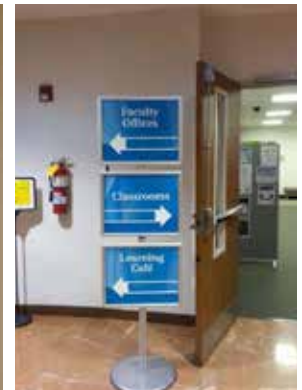

Gazebo

Gazebo



Stand out from the crowd with an eye catching customized Pop up Gazebo or Event tent by creating an unrivaled advertising medium whether you are generally promoting your business or just personalizing your product.



200x200 cm
300x300 cm

300x450 cm

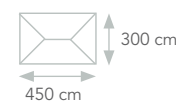

General Specifications

Aluminum / Steel Frame
Ropes, pegs and bag included
Waterproof Canvas 100% Polyester Textile
Digital Dye Sublimation

Available Sizes:
200cm(H) x 200cm(W)
300cm(H) x 300cm(W)
300cm(H) x 450cm(W)

Vehicle Branding



Vehicle Branding

Marketing is a crucial investment when it comes to present your brand out to the world.

Make it a priority to get the best return on invest in advertising your product through our excellent vehicle branding.

If used effectively can be the best choice to promote your brand.



General Specifications

You can get a quick quotation from our professionals depending on the type of vehicle that you want to brand. Simply get in touch today.

Wheel Covers

Spare Tyre covers

Communicate your brand and values to your customers everywhere including the traffic with every attractive full color printed spare tyre covers. The printing is done on a tough and durable PVC material. Create your own design to put on your vehicle or simply have us design on for you.

We have in stock two sizes however you can also order a custom size. (We will need the dimensions and size of your spare wheel in order to make you a spare wheel cover).

Available sizes:

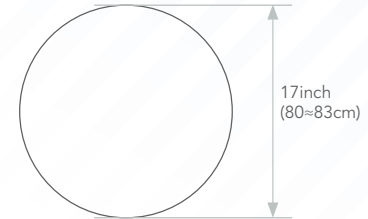
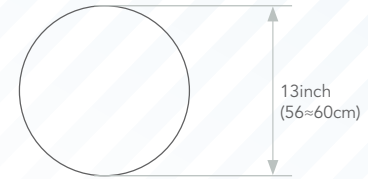

General Specifications

Material: PVC
Neatly hand sewed and crafted to fit tyre size
Sizes: min. 13inch(56~60cm), max. 17inch (80~83cm)

Canvas Printing & Stretching



Having trouble filling that two-storey loft wall? We specialize in large format canvas printing for photos that need a little extra space. Make your walls come alive with our custom sized canvas art prints.

Available frame Colors:



Wall Mounted Acrylic Frame



Magnetic Display Board

Available Sizes: A4 & A3 sizes



Queue Stands

Artwork:
Resolution 300ppi or higher
Acceptable printing file types:



Ask our team for specifications of any item you may need.
Please call: +255 736 551 608 Email: design@brandvision.co.tz

Creative

SUBLIMATION & HEAT PRESS



Promotional Mugs

Classic Round Mugs



Available Colors:



Looking for the perfect mug for your brand? With our different range of mugs we are sure to have the style just for you.

Magic Round Mugs

Has a unique thermo-chromic coating. This allows the branding to magically appear when hot liquid is added and then disappear again as it cools.



21cm

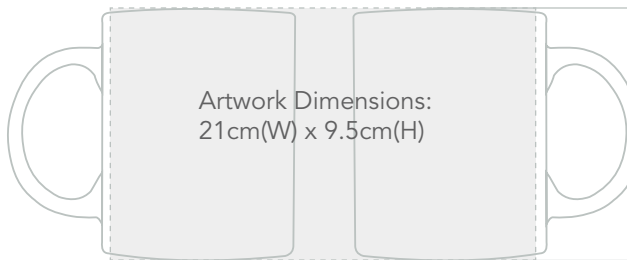

Artwork Dimensions:
21cm(W) x 9.5cm(H)

Round Two Tone - Mugs



9.5cm



General Specifications

Mug Capacity: 330ml
Diameter: 81mm, 95mm(H) x 210mm(W)
Gift Box: 107mmx112mmx91mm.

Glitter Mugs



Ceramic 11oz sublimation coffee mug assorted sparkling (Glitter Effect) packed in white gift box.

Promotional mugs will put your advertising logo and slogan right in clients hands.

Available Colors:



Glitter Tumbler - Stainless Steel

Double wall coffee cup with a timeless curved design and a secure push on lid. It has a stainless steel outer wall and a polypropylene inner wall which keeps drinks hot for longer.

Capacity: 360ml - 12oz



Clip-On Mug Stainless Steel

Stainless steel which laser engraves to a natural etch. It features a carabiner handle to easily attach the mug to backpacks and bags, perfect for camping and day trips.

Available only in white: 300ml

Magic Two Tone Mugs with Spoon



The magic mugs also come with two tone option as above.

Mug without Spoon is also available.



Inner Rim Handle Mugs

15oz Mug, with wide space for Full Color Printing of company logo / message / illustration.

Artwork:
Resolution 300ppi or higher
Acceptable printing file types:



Mugs above are loose packed or in optional gift box.
These products are not dishwasher safe and
handwashing is recommended.



Spoon Mugs 11oz



Sublimation Blanks Mugs
Capacity: 12oz
White/Two Tone Color with Spoon.
All mugs come individually packed in a white box.

Available Colors:



Enamel MugS

This unique mug has admirable qualities – durability, smoothness and chemical-resistance. It can assume brilliant, long-lasting colors, and cannot burn. If you drop it, it may chip but it won't break.

Available in Enamel Mug White with Black Rim.
Capacity: 360ml -12oz

Executive Extra Wide Mugs



Available Colors:



Capacity: 14oz



Artwork:
Resolution 300ppi or higher
Acceptable printing file types:



Mug Details:
Material: Ceramic
Printing: Sublimation 14oz Two -Tone Color Mug



Glass Mug (Frosted)



The frosted gradient rainbow shot glasses can be printed with custom designs and serve excellently as drinking utensils.
Capacity: 10oz



Available Colors:



Glass Tumbler with Lid & Straw (Frosted)



Glass tumbler with Lid and Straw.
Capacity: 15oz/450ml
Available Color: Clear

15oz/450ml Glass Tumbler with Lid & Straw (Frosted)



15oz/450ml Glass Tumbler w/ Lid & Straw (Frosted)

12oz Mason Jar (Clear)



Capacity: 12oz
Artwork size: 8.8cmx11cm
Available Color: Clear



Artwork:
Resolution 300ppi or higher
Acceptable printing file types:



The glass tumbler & mason jar are made in premium stainless steel and double-wall vacuum insulation with lid and hole at the center for insertion of straw.





Travel Bottles

Travel Bottles

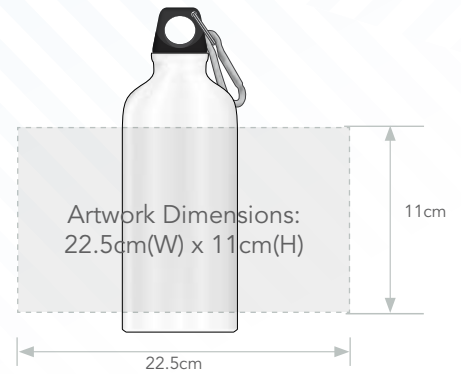

Classic 750ml stainless steel drink bottle and is laser engraved to a shiny steel finish, except for the stainless steel bottle which is engraved to a natural etch.

Available Colors: ● ●

600ml Travel Bottle



Colors:



Choose from three variations of the bottle lid that suits your function.

General Specifications

Bottles above are loose packed or in optional gift box. These products are not dishwasher safe and hand-washing is recommended.

750ml Aluminum Water Bottle With Cap (White)



This sublimation aluminum bottle is super lightweight and portable, easy to carry, and can fit in your backpack and your bike bottle holder, and won't add any extra weight to your luggage!



Available Cap Colors:



16oz Stainless Steel Tumbler (White)



This stainless steel tumbler can keep your hot beverage hot. With the handle on the lid, the tumbler can be carried everywhere, the surface can be fully imprinted with your favorite images by sublimation.

750ml Aluminum Water Bottle With Cap (White)



The bottle has a handle which is very portable and easy to grab outside. And it is with large capacity, which makes it a perfect bottle for sports.

It will be a great companion when you are hiking, camping, or doing some other outdoor activities.

What's more, the bottle can be imprinted with images by sublimation printing. You can design your own bottle and make it unique just for you.

Artwork:
Resolution 300ppi or higher
Acceptable printing file types:



Material: Aluminum
Size: 7.3cmx21.5cm
Available Color: White



28oz/850ml White Aluminum Water Bottle With Cap



850ml Water Bottle with Color Cap comes with quality sturdy colored caps for perfect daily use. Customize with pictures, designs, names, logo and many more. Hydrate in style, personalize your own water bottle with amazing designs.

Capacity: 28oz/850ml
 Size: 7.2cm×25.3cm
 Material: Aluminum
 Color(s): Silver

Available Lid Colors:



20oz/650ml Silver Aluminum Water Bottle With Straw Cap



Water Bottle with Color Cap 650ml comes with sturdy vibrant straw cap and a handle for easy daily use. Personalization can be done with designs, pictures through Brand Vision's design printing service.

Capacity: 20oz/650ml
 Size: 7.2cm×23.5cm
 Material: Aluminum
 Color(s): White, Silver

Available Lid Colors:



Artwork:
 Resolution 300ppi or higher
 Acceptable printing file types:



Note:
 Each travel bottle or tumbler type has its own specific dimensions for printing, please be advised.



750ml Aluminum Water Bottle



Material: Aluminum
Bottle Color: White
Net Weight: 137g

Size: 6.4cmx21.1cm

Available Lid Colors:



500ml Stainless Steel Flask With Transparent Lid



The Flask's inside is made of 304 stainless steel and outer 201 stainless steel. It insulates for more than 8 hours. The Bounce lid preserves heat and leak proof and can be used as a water cup.

Size: 6cmx24cm
Capacity: 500ml

Available Colors:



18oz/550ml & 32oz/950ml Water Bottle With Straw Cap



Material: Double-walled stainless steel, with vacuum insulation.

Net Weight: 425g

Size: 9cmx25.2cm (32oz) & 7.5cmx21.2cm (18oz)

Available Color: White

Artwork:
Resolution 300ppi or higher
Acceptable printing file types:



Stainless steel water bottles with wide mouth straw lid & rotating handle (White)
Available Sizes: 32oz/950ml and 18oz/550ml



600ml Travel Bottle



Available Colors: ● ●

Artwork Dimensions: 22.5cm(W) x 11cm(H)

Cola Water Bottle SS

Gift Box



Available Colors: ● ●



500ml aluminum drink bottle with a timeless design and a smart painted finish.

Artwork Dimensions:
20cmx10cm.



Travel Tumbler

Large 550ml double wall, vacuum insulated stainless steel tumbler which will keep drinks hot for hours. It has a secure push on lid with a splash proof sliding closure.

Colors: ● ●



Artwork:
Resolution 300ppi or higher
Acceptable printing file types:



Note:
Each travel bottle or tumbler type has its own specific dimensions for printing, please be advised.



Glitter Bottles SS -500ml -17oz



Glitter stainless steel cola shaped bottle tumblers for sublimation or engraving, artwork can be printed in a 20cmx10cm area.

Available Colors:



Flask SS



Flask capacity: 750ml
Available in only white

Artwork Dimensions:
22.5cm(W) x 11cm(H)

Spray Bottle Alum



White Color
Capacity: 400ml
Artwork Dimensions:
22.5cm(W) x 6cm(H)

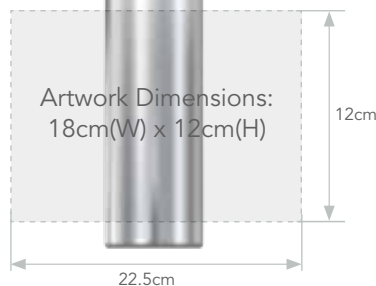

Artwork Dimensions:
18cm(W) x 12cm(H)

Portable Bamboo lid Bottle SS

Double wall vacuum insulated stainless steel drink bottle which will keep drinks cold for 24 hours or hot up to 12 hours. It has a trendy screw-on lid with a stainless steel carry handle that offers a prominent branding opportunity. Available in full stainless steel or with a bamboo veneer. Bamboo is a natural material that produces unavoidable variances in the grain pattern, color and branding.

Capacity: 650ml
Bottle Size: 18cmx12cm
Bottle Lid size: 4cm circle.

Umbrellas

Premium Type Umbrella

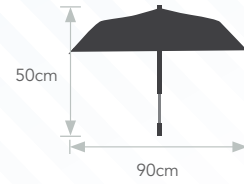

Five Fold

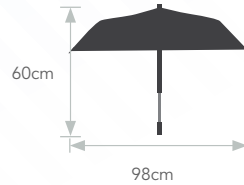
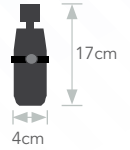

Three Fold

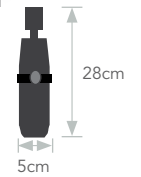

Compact Type Umbrella



Eight-panel automatic opening umbrella which has a polyester canopy with a stunning two-tone heather finish. It has a black eight-rib fiberglass frame and a fiberglass shaft with a soft EVA hand grip. Other features include metal tips, a velcro tie and a matching heather sleeve.

Company Logo can be printed together with other brand details or message in either single color or a combination of not more than two colors.

Available Colors:



General Specifications

Material: Polyester
Half Sleeve, 200gsm
Sizes available: Premium, Compact



Mobile Covers



Personalized printed mobile cover, ideal gift for all purposes from corporate advertising to occasions like weddings and birthdays.

Great range of mobile covers to choose from.

Mobile Covers

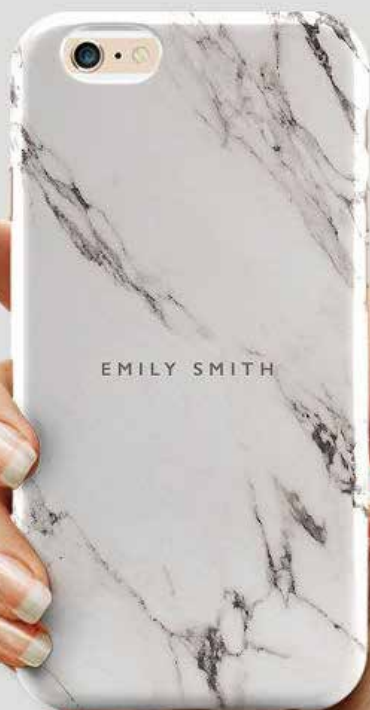

Covers Available :

Samsung S9, S9+, S10, S10+, Note 10, Note 10+
iPhone 11, 11Pro, 11Pro Max, X, XS Max, XS, XR



Also Available :

Samsung Note 5, S6, S6 Edge, iPhone 6, 6s, 6s+

Colors:



General Specifications

Water proof plastic cover
Sizes varies with the owner's device. Please share your artwork or get it professionally done by our team.

Finger Ring Phone Holder



Get a good grip on your smartphone with this metal ring holder that showcases your favorite picture.

Holder securely mounts to the back of your device and helps safeguard it from dropping. Recommended for use with phone case.

Oval Plastic Keychain

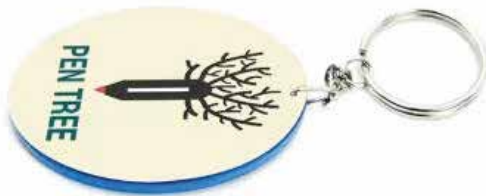

A standard advertising keychain will carry the businesses name and contact information and often a logo.

Size available: 48mmx68mm

Rectangular Plastic Keychain



The Keychain also allows for more illustrative designs with this rectangular shaped holder that has a larger surface for print.

Size available: 57mmx82mm

Artwork:
Resolution 300ppi or higher
Acceptable printing file types:



Keychain Details:
Plastic, Ring: Zinc alloy
Printing: Sublimation



Mouse Pads

Mouse Pads



The mouse pad is a great tool for marketing and perfect as a gift. It can be used both at home and in the office.



Mouse pads are made with a non-slip Natural rubber Base.



And will not fade with repeated cleaning, plus it's easy to clean.



Using high-quality spandex and advanced sublimation technology, the color is bright and long lasting.

Size available: 20cmx25cm
Thickness: 3mm

Floor / Door Mats

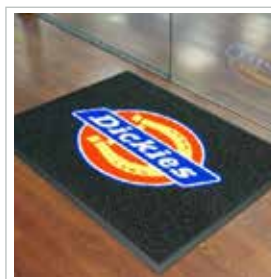

Vacuum or steam clean. Our logo mat is a great first impression at the door to your office. You can also use it at trade shows, job fairs, or exhibitions.

General Specifications

Spandex with sublimation finish
Thickness: 3mm
Sizes available: 38cmx58cm



Stone Slates



1

Square Stone



2

Round Stone



3

Heart Stone



4

Left Contour



5

Door Shaped



6

Rectangular Stone



7

Upper Contour shaped
Stone

8

Rectangular Stone
with Frame

9

Medium Rectangular
Stone with Frame

Cherish the special moments and make them the most beautiful part of your life using right items.

Photography among others helps to capture the precious time of one's life journey. Our photo slates are done with very high quality and clarity.

The artistic effect is good: the characteristics of the magic stone painting is that the picture is exquisite and the color is thick,

long lasting and vivid. Moreover, the slate is uneven, which enhances the three-dimensionality of the picture, and different visual effects can be seen from different angles.

The picture stone slates are an amazing choice as a gift and a souvenir.

Available sizes:

Small: 15cmx15cm; 1, 2, 3, 10cmx15cm 6, 12cmx17cm 8,
Medium: 20cmx20cm; 6, 7, 20cmx25cm 2, 20cmx30cm; 1,
Large: 30cmx30cm; 1, 5, 7, 30cmx16cm; 6.

Artwork:
Resolution 300ppi or higher
Acceptable printing file types:



Sublimation is a digital printing technology that uses heat transfer to apply an image to surfaces such as decorating apparel, signs, banners and many more.



Hotel Slippers

Hotel Slippers



Disposable indoor bathroom spa linen slipper hotel slippers.
Plain without printing.
Sizes available: S, M(F), L

Flip Flops



We create truly custom footwear using your own artwork by printing your designs on to flip flops.

Plain without printing
Sizes available: S, M(F), L

Pillow Covers



Personalized pillows are a great way to create one-of-a-kind accent pieces for friends and family. Whether you feature treasured photo memories or celebrate their favorite color, you can create a thoughtful, unique piece they'll always love to keep close.

Available Colors:



General Specifications

Soft, durable
100% polyester pillow
Size available: 14" x 14"





Sublimatable Socks



These high quality sublimation printed socks will provide optimum comfort with style wherever to complement your office look or an eye-catching statement for an extravagant outfit.



Material: 95% Polyester 5% Spandex
Ribbed tube, Cushioned bottoms one size
(5-12 US, 37-43 EU, 3-12 UK)

Available Colors:



You can choose from our designs or simply give us yours to print.



Sublimatable Socks



Executive Wall Clock



White anniversary MDF sublimation clock
Size: 20cmx20cmx0.5cm, for home or office.
Can be customized as a desktop version depending on your preferences.

General Specifications

Clock Preferences

Base Material: MDF / Acrylic / Customized frame

Size: 20cmx20cmx0.5cm / Ask for optional size

Complimentary

OFFICE & ACCESSORIES



Name Badges



Metallic & Plastic Badges

1



2



3



4



5



Badges carry branding. They complete a look, endorse an image, and are a vital visual connection between you and your audience. Our name badge comes with: full color printing of logos and text; with option of pin, clip or magnetic fittings and are scratch resistant.



Artwork Dimensions: for Badge types: 1, 2 & 3

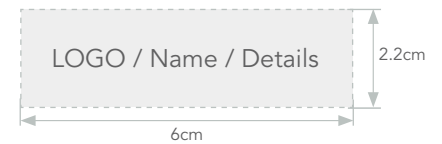

Badge types: 4 & 5

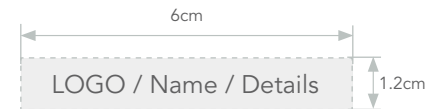

Available Colors:



Flag Pin & Medal Badges



Landscape & Potrait Identity Cards



Whether you run a corporate business or a small cake shop; ID cards show uniformity among the employees at events or conferences or at the office. We offer two options for premium quality ID cards printing; either on a single side or both sides (front & back).

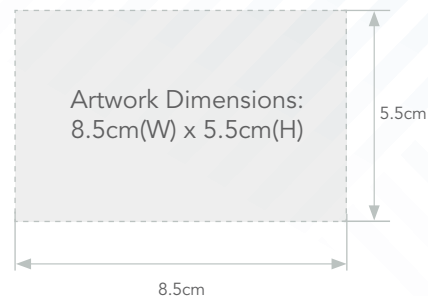

Card Holders



All available holders are transparent.

General Specifications

ID card material: PVC with premium matte finish
Artwork dimensions: 5.5cm(H) x 8.5cm(W)
Artwork should be 300ppi or greater.

Identity Card

Lanyards



Lanyards



Detachable Buckle

Safety Clip & Detachable

Our lanyards are eye-catching and printed full color. Or would you like your logo or name printed in one or two colors on a pre-colored lanyard?
Our lanyards are printed ideally for you with a high quality finish.

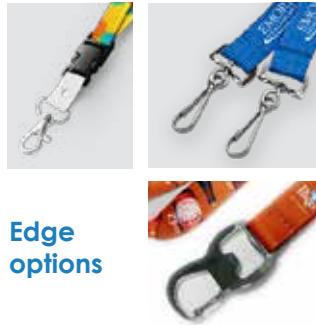

Edge options

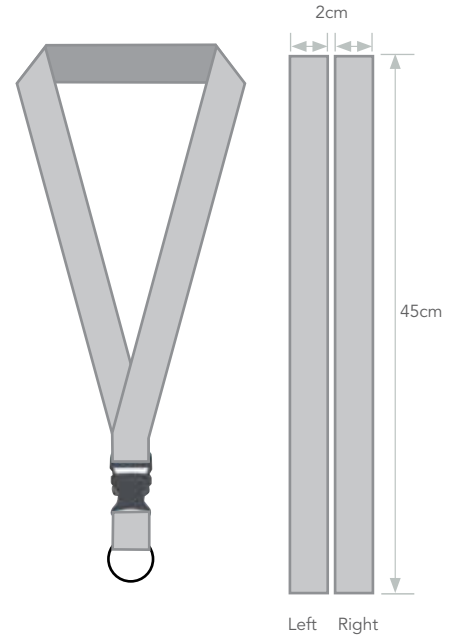

General Specifications

Material: Polyester, Sublimation / Screen printing
Dimensions: 2.5cmx90cm Artwork: 2cmx90cm
Fitting: Single slide lock

Retractable Badge Holders



Place your company name at front. Epoxy print finishing.



Available Colors:



Wrist Bands



Material:
Tyvek



Material: Silicon



Available Colors:



Wrist Bands USB drives



Interlocking Band



USB Drives

USB Drives

Memorable corporate logo USB flash drives which is used as powerful marketing tool in trade shows and many other occasions.

USB flash drives
Metal swivel in 4GB & 8GB

Available Colors:



USB ID card flash disk
Memory : 8GB & 16GB



Crystal pens with touch pad
USB Flash Drives Memory : 4GB & 8GB

Power Banks



Silver & Black : 4000 mAh
 Printing Options : UV Printing &
 Screen Printing



White 5000 mAh
 Printing Options : UV Printing & Screen Printing



Branded mobile battery chargers are not only a great way to stop you from having dead battery at an awkward moment, but are also a practical and usable promotional product. Customize our external battery chargers with your logo to enhance your brands identity and awareness.

Digital Table Clocks

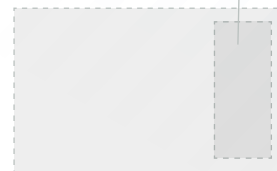

Company logo or photos can be printed in this area.

Universal travel adapters compatible with worldwide plug and socket.



Desktop Clocks



Company logo or photos can be printed on the surface.

Available Colors:



Artwork:
 Resolution 300ppi or higher
 Acceptable printing file types:



Ask our team for specifications of any item you may need.
 Please call: +255 736 551 608 Email: design@brandvision.co.tz

Promotional Pens

Standard Pens



Promotional pens come in a variety of colors that have been made from hardened plastic to suit your daily use. Company Logo can be printed together with other brand details or message in either single color or a combination of not more than two colors.

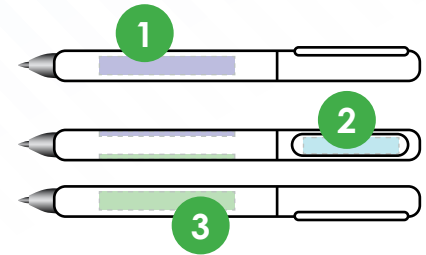

Available Colors:



Printing Area on Pen
Barrel front & back (1&3): 4.7cmx0.9cm
Laser engraving on pad (2): 3cmx0.7cm

Executive Pens

Give your company a polished look with these classy executive pens.



Available Colors:



General Specifications

Opening Style: Click
Material: Plastic, Hardness: Medium soft
Point: Oil ball pen 0.5mm diameter



Cufflinks



Printing done with Epoxy Finish

Available Colors:



Self Inking Stamp

Want to have corporate identity and uniqueness? Personalized stamps will help to keep track and avoid forgery. Customized to your design specifications and size.



Specification Options:
 Circular shape, Diameter: 40mm, 45mm
 Rectangular shape: 10mmx69mm, 40mmx50mm, 40mmx60mm
 Dater or Non-dater

Available ink:



Seal Embossing Press

Embossing press is ideal for embossing a wide range of different materials. They give a professional and official finish to company documents. But of course they can also be used in many other ways:

Available size: 41mm



Give your office stationery a corporate elegant feel!

Trophies & Plaques

Trophies and Medals



Corporate Awards alongside employee recognition awards deliver the ultimate impact and send a clear message of excellence.

To see our current trophy selection, please contact our team for the available options.

Wooden Plaques



We have a wide range of options to suit corporate clients, sporting awards and lovely giveaways.

Crystal Plaques

Available options include; home or office display, lovely giveaways and gifts for different occasions or events like birthdays, weddings, valentines day and many more special dates.



High Quality

OFFSET & DIGITAL PRINTING



Marketing Materials



As a quality print house in Tanzania, we can provide you with the complete printing package; right from design and typesetting to pre-press services, straight through to press and finishing services. We print; posters, leaflets, fliers, brochures, profiles and other prints-on-demand.

Publications



Additionally, we have in-house capacity in handling the finishing process through the use of cutting, stitching, folding and creasing machines that contributes significantly to speedy compilation of your publications such as; magazines, annual reports, text books, educational books, newsletters, company profiles, catalogue books, coffee table books, etc.

Printing size range:

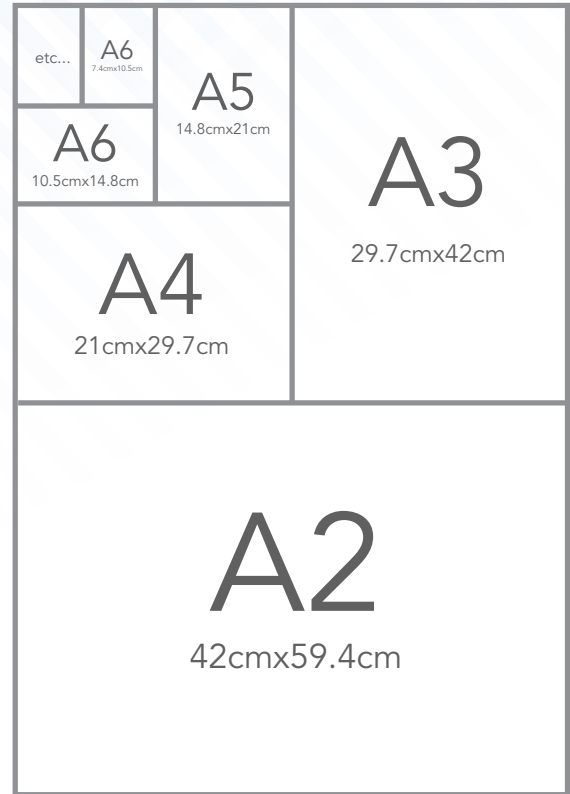

Printing color range:



We print other spot colors on request in addition to the process colors in order to achieve the accuracy of your desired color.

Artwork:
Resolution 300ppi or higher
Acceptable printing file types:



Please specify the type of job you need to print and ensure that the print work (pictures, illustrations, text, graphs, maps etc.) as been proof read and approved before you submit it.

Envelopes



Whether a simple, one-color remittance envelope or a full-color piece featuring bright, colorful imagery and text, we can design and print envelopes to suit any need.

Print sizes: A3, A4, A5, A6, DL

Material: white 170gsm

Self adhesive sealing

Letterheads

Impress customers, companies or prospective employers with personalized A4 letterhead. It's a great way to make sure your contact information is easy to find, and it also helps you look professional. A variety of high-quality stylish paper is available for printing.



Presentation Folders

Interlocking folders come in A4 or A5 size and are the perfect way to tie up loose ends. These are excellent at conferences and for big presentations.

Finishing Options:

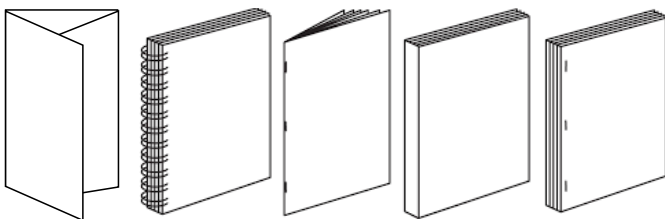

Folding , binding (spiral, perfect, sewing, mixed) , saddle stitching as well as lamination (Glossy / Matte finish)

Available Paper specifications:

- Glossy
- Matte
- Newsprint
- Recycled
- NCR paper

Paper weight/thickness range: 80gsm, 90gsm, 130gsm, 170gsm, 200gsm, 250gsm, 300gsm, 350gsm

Artwork:

Resolution 300ppi or higher
Acceptable printing file types:



Ask our team for specifications of any item you may need.
Please call: +255 736 551 608 Email: design@brandvision.co.tz

Table Talkers



Table Top Prints



Table menus don't need to be limited to fixed booklet designs. With our free-standing table talkers, you can display one to three sides creatively to promote your weekly events, special offers or chef's specials!

Finishing Options: Premium uncoated, Glossy / Matte Lamination
Size: A5, A6, Portrait (DL)



Acrylic Table Talk Holders



Desktop sign holders are perfect for displaying posters, menus, product specifications and so on. The simple design makes it easy to insert and swap graphics in seconds via the slit opening.

Printing options:

- Color: Transparent
- Sizes: A5 Portrait / Landscape orientation
- Material: Clear Strong Acrylic
- Sides: Single or Double Sided
- Min. order: 10 pcs

Diaries & Notebooks

The ideal way to ensure that clients carry your brand in their hands is by using excellently bound and designed notebooks/diaries.

Personalize each diary/notebook with your identity; a guaranteed way for them to keep you in mind every time they carry it along.

Specifications and features include;

- Hard cover, Soft cover, PU cover
- Fully custom inners, standard inners
- Special effects: foiling, SPOT UV, laser die-cut, embossing
- Binding option: perfect bound, wire-o-wire, executive file-o-file folders
- Sizes: A5, B5, A4 or custom preference



Executive Folders & Notebooks

Organize information, documents, gadgets, and accessories in one executive corporate folders. Share them as a gift to your clients who will remember your brand through the year.

Available Colors:

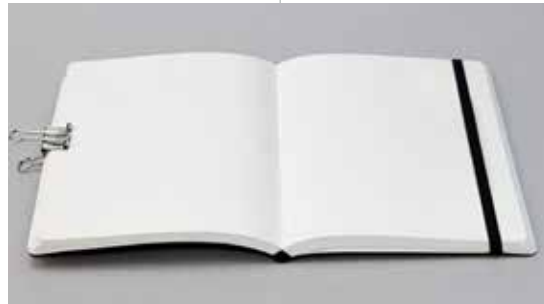
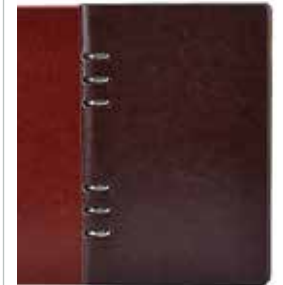

Calendars

Calendars are a great marketing tool especially when printed in superior quality and you are assured of optimum brand visibility all year round.

We design and print personalized desktop and wall calendars of a variety of sizes and designs as per the following specification options;

Wall Calendar

Size: A2, A3, A4

Paper: Glossy / Matte

Paper weight: 115 - 250gsm

Binding: Metal Rim, Spiral

Extras: Flysheet (full color, Bond 70gsm)



Desktop

Size: 21cmx15cm, 20cmx20cm

Paper: Glossy / Matte

Orientation: Potrait / Landscape

Stand: Chipboard 450 gsm

Binding: Wire-O-Wire



General Specifications

Artwork:
Resolution 300ppi or higher
Acceptable printing file types:



Laser & Dye cuts



For the longest time, stickers have been linear in shape. People get multiple stickers printed on a sheet. And these individual labels are then cut into boring squares and rectangles. Traditional methods will not work for stickers having non-linear edges.

We are leading printer of all kind of cosmetic labels, juice & beverage labels, pharmaceutical labels , agrochemicals & pesticide labels, self adhesive labels, printed labels, PE Label, PP labels & FMCG Labels

Our unwavering focus on quality is our way forward to success, which can be seen in our offerings that are highly acclaimed for strong adhesion, wide variety of customized sizes and shapes, superior surface finish, striking colors, moisture resistant properties and competitive pricing structure.



Artwork:
Resolution 300ppi or higher
Acceptable printing file types:



Please specify the size and type of label you need for more details.



Professional WEBSITES & Social Media Platforms



Stable, secure & effective systems

Creative, engaging & user friendly

GET STARTED



Contact us & take advantage of our comprehensive services;



Hosting



Website Design



Redesign



Social Media Management



High
Quality
you can depend on!



GRAPHIC
DESIGN



LARGE
FORMAT



SCREEN
PRINTING



OFFSET
PRINTING



DIGITAL
PRINTING



SIGNAGE
WORKS

DESIGN • PRINT • BRANDING • PROMOTION

+255 736 551 608

sales@brandvision.co.tz

brandvisiontz

www.brandvision.co.tz